

CADEIRAS
COMPRADA

MESA REDONDA
Ø140CM COMPRADA

TAPETE
250x250cm
COMPRADO

SOFÁ
COMPRADO

MESA DE CENTRO -
ACERYO PESSOAL

POLTRONA
COMPRADA

APARADOR
COMPRADO

214

211

301

3

3

A1

II
III

II
III

II
III

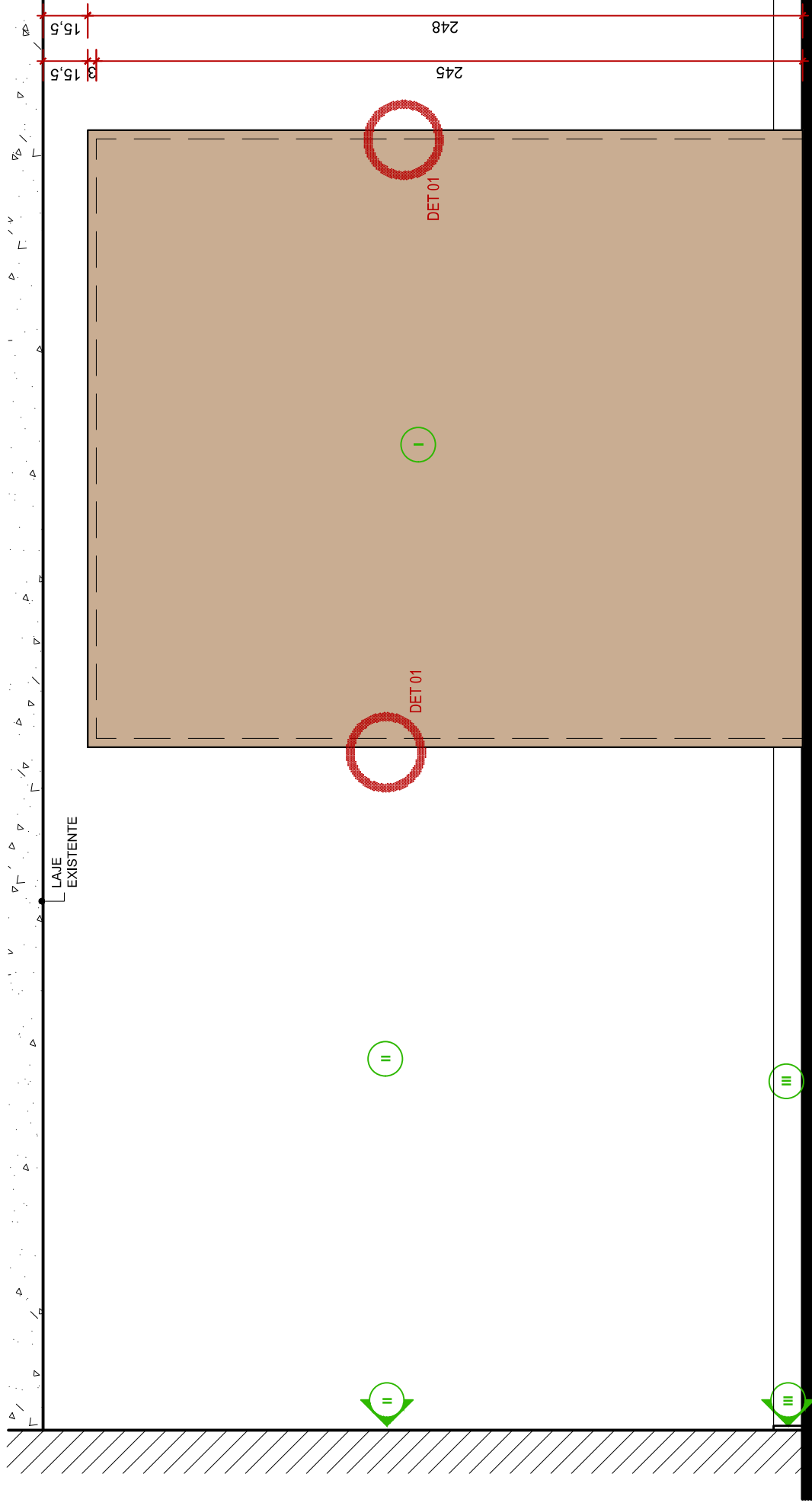

237

237

208

214

3

3

A3 A1 A3

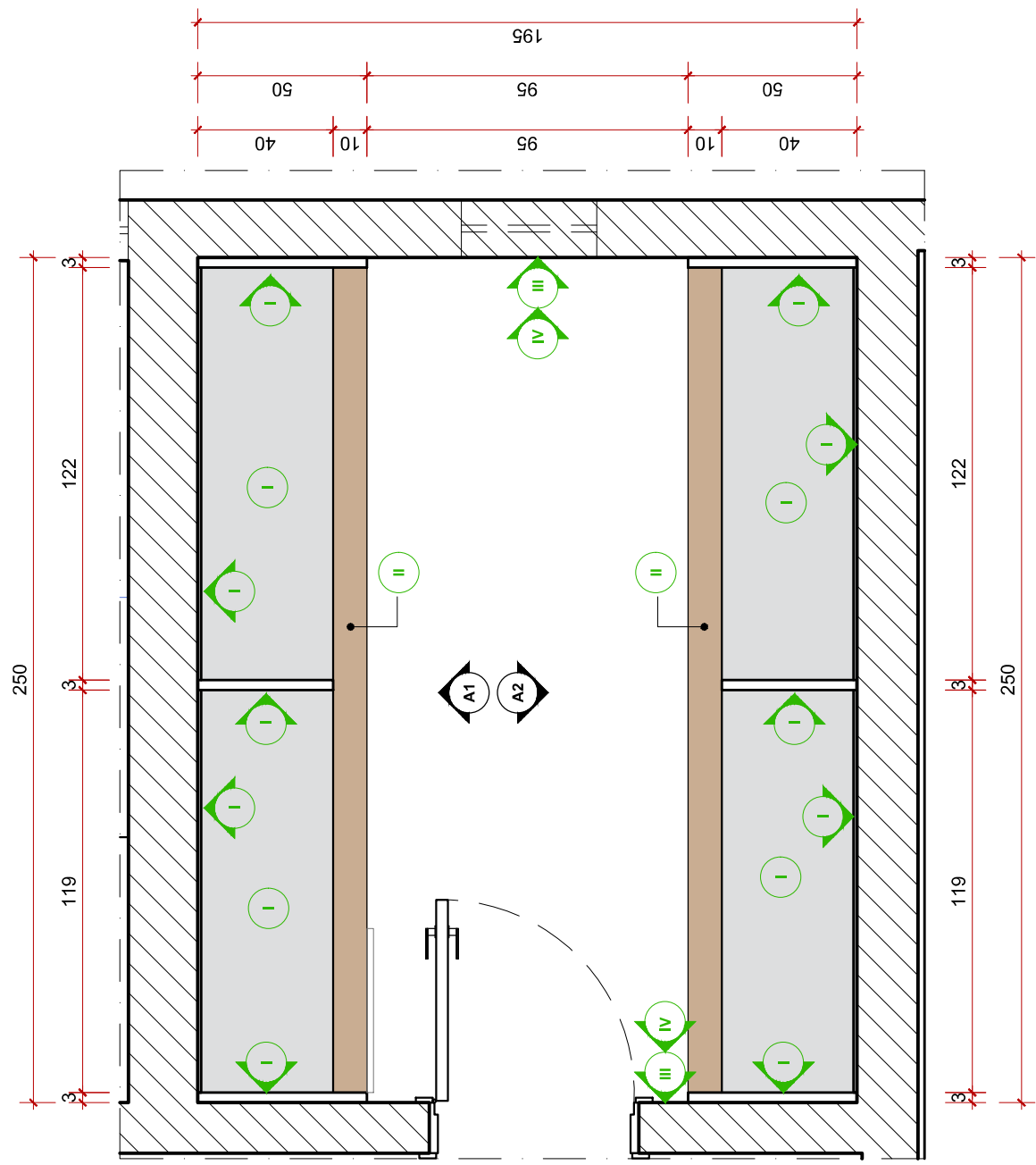

PLANTA EXECUTIVA - ARQUIVO
 PLANTA BAIXA
 ESC.: 1:20

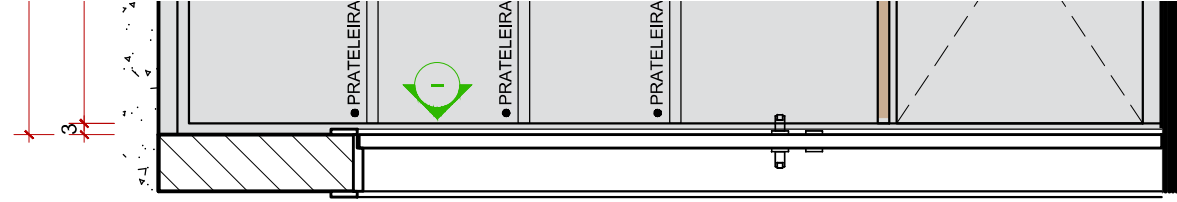

VISTA A1
 VITSA
 ESC.: 1:20

603

128

210

20

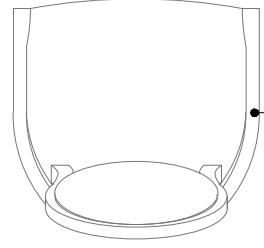
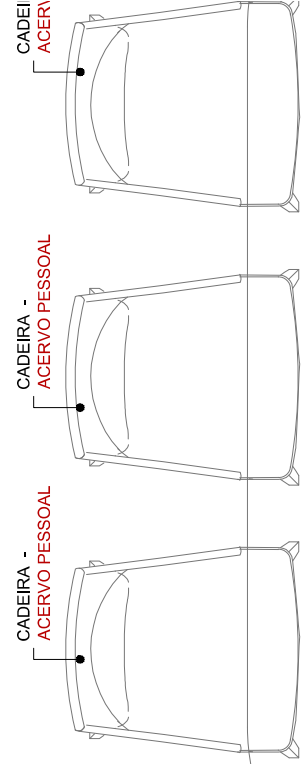
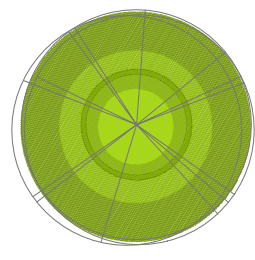
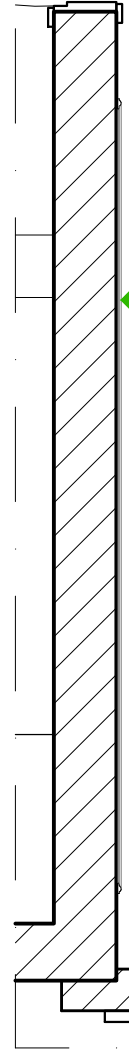
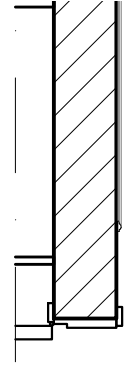

BUFFET - ACERVO
PESSOAL

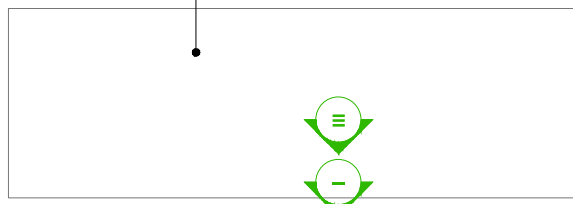

A1

A3

A3

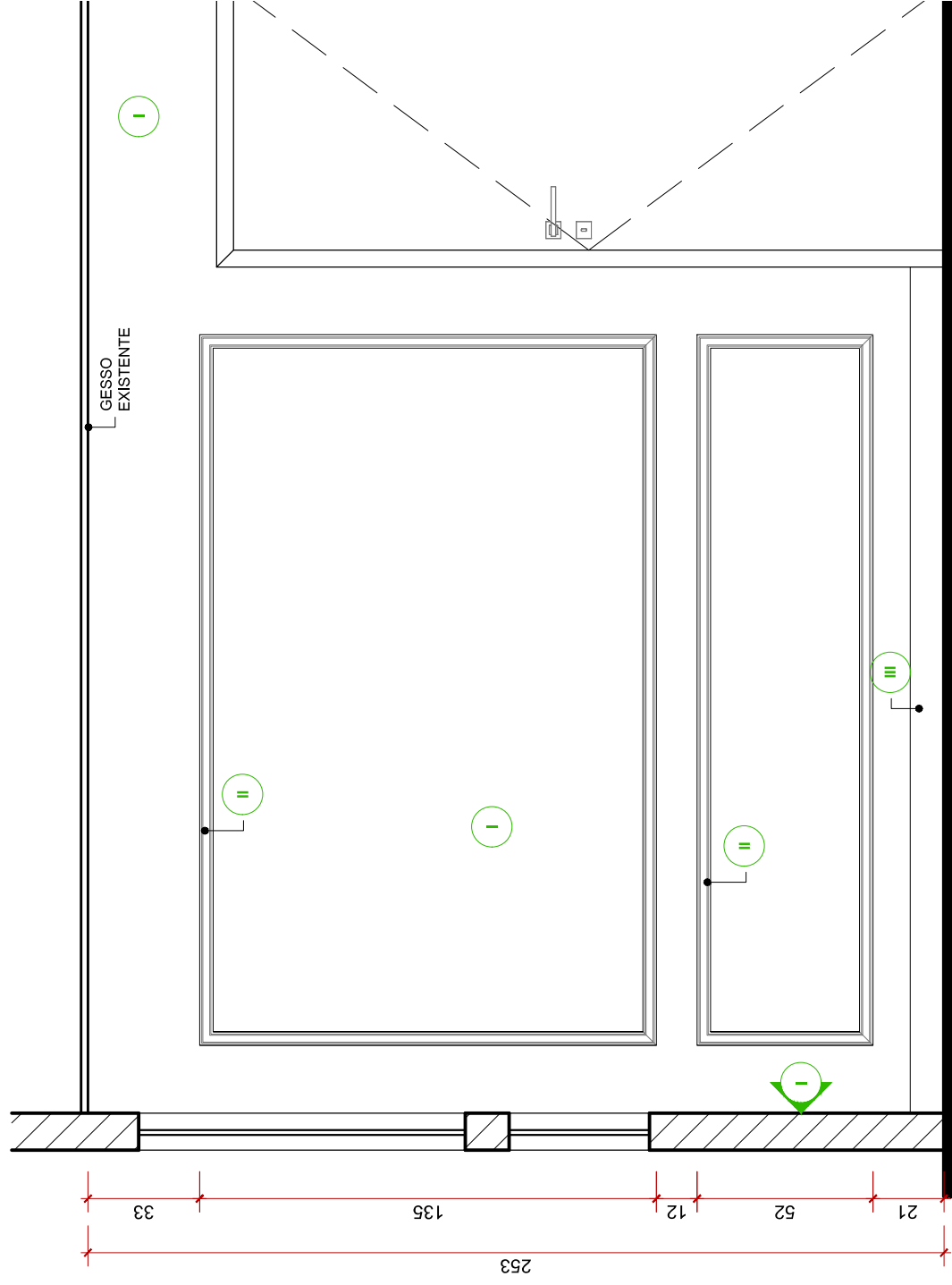

VISTA A1

VISTA

ESC.: 1:20

20

210

128

603

REVESTIMENTOS

- I LACA BRANCA
- II MDF NOGAL CHAMPAGNE - GUARARAPES
- III MDF BRANCO PLATINUM - ARAUCO
- IV RODAMEIO 468 - SANTA LUZIA
- V RODAPÉ 505 - SANTA LUZIA
- VI RODAPÉ - EXISTENTE
- VII PINTURA - EXISTENTE

*CONFERIR ALTURA DO RODAPÉ EXISTENTE ANTES DE EXECUTAR MARCENARIA.

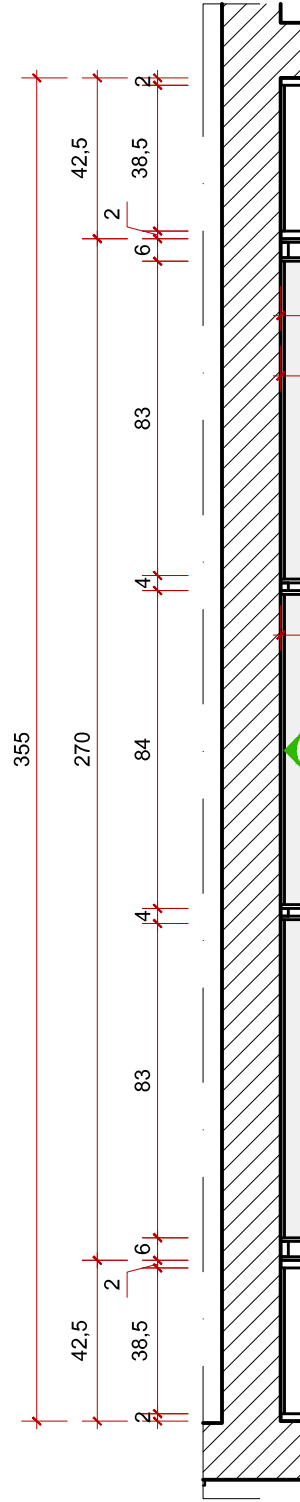

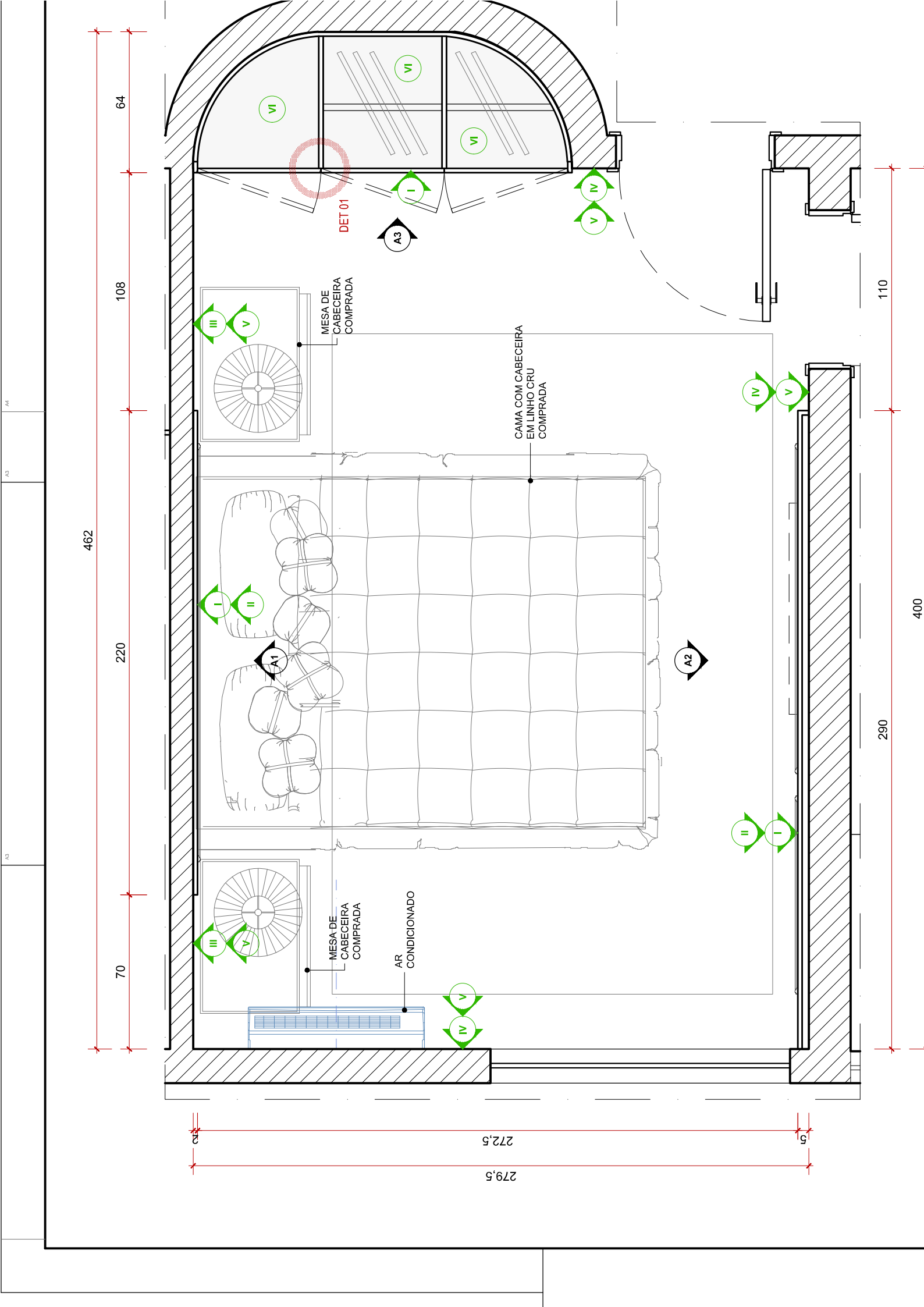

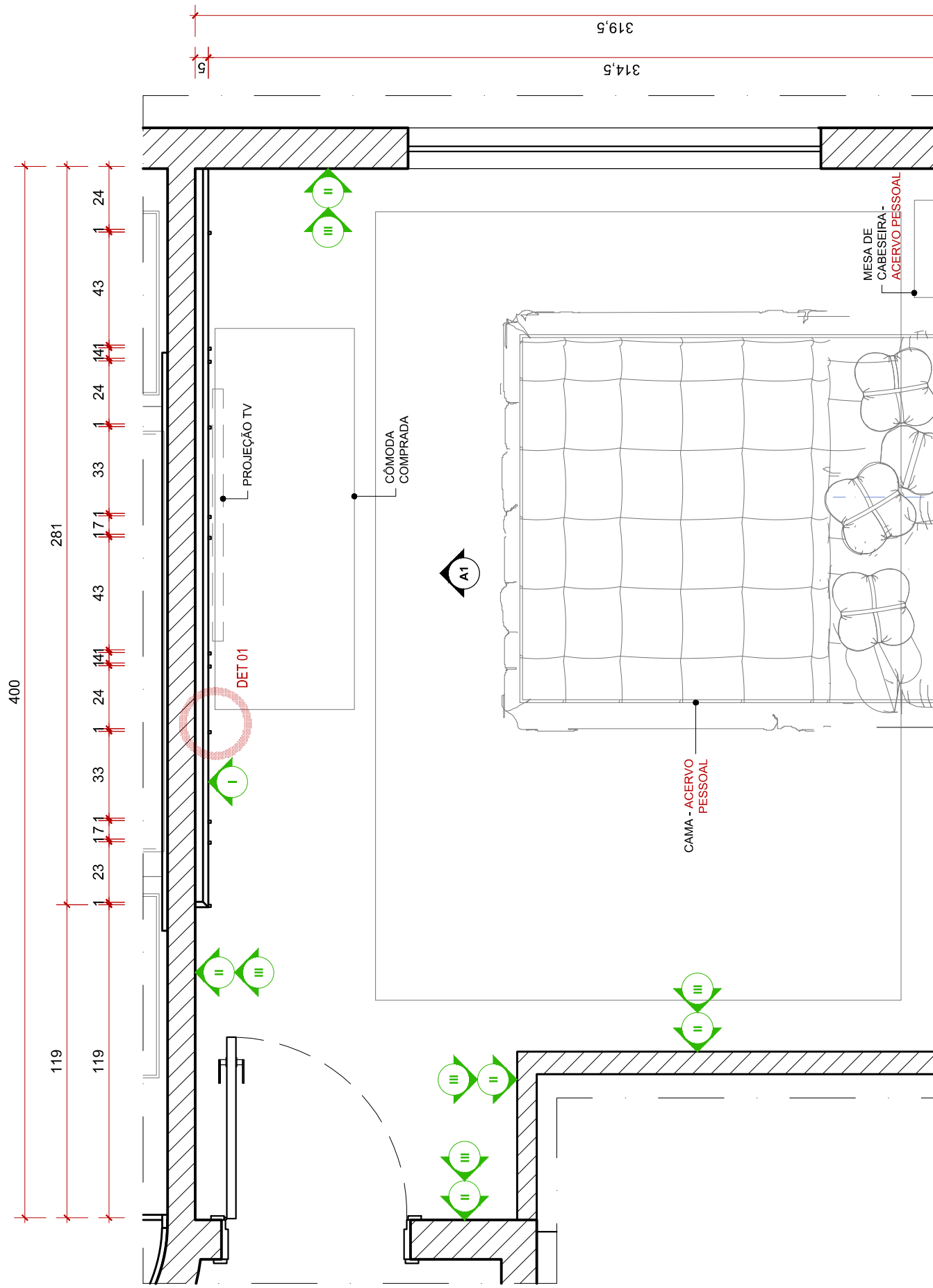

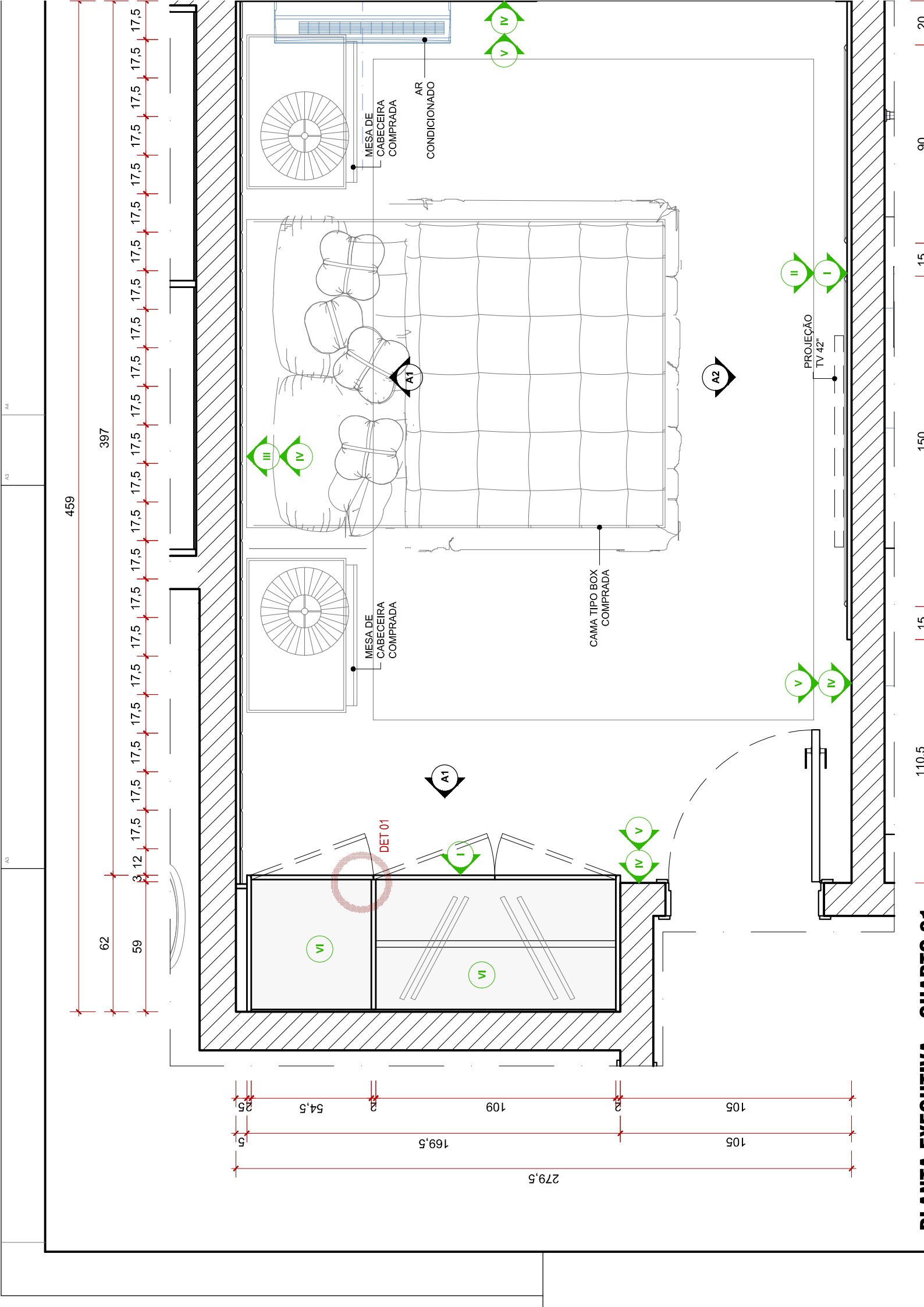

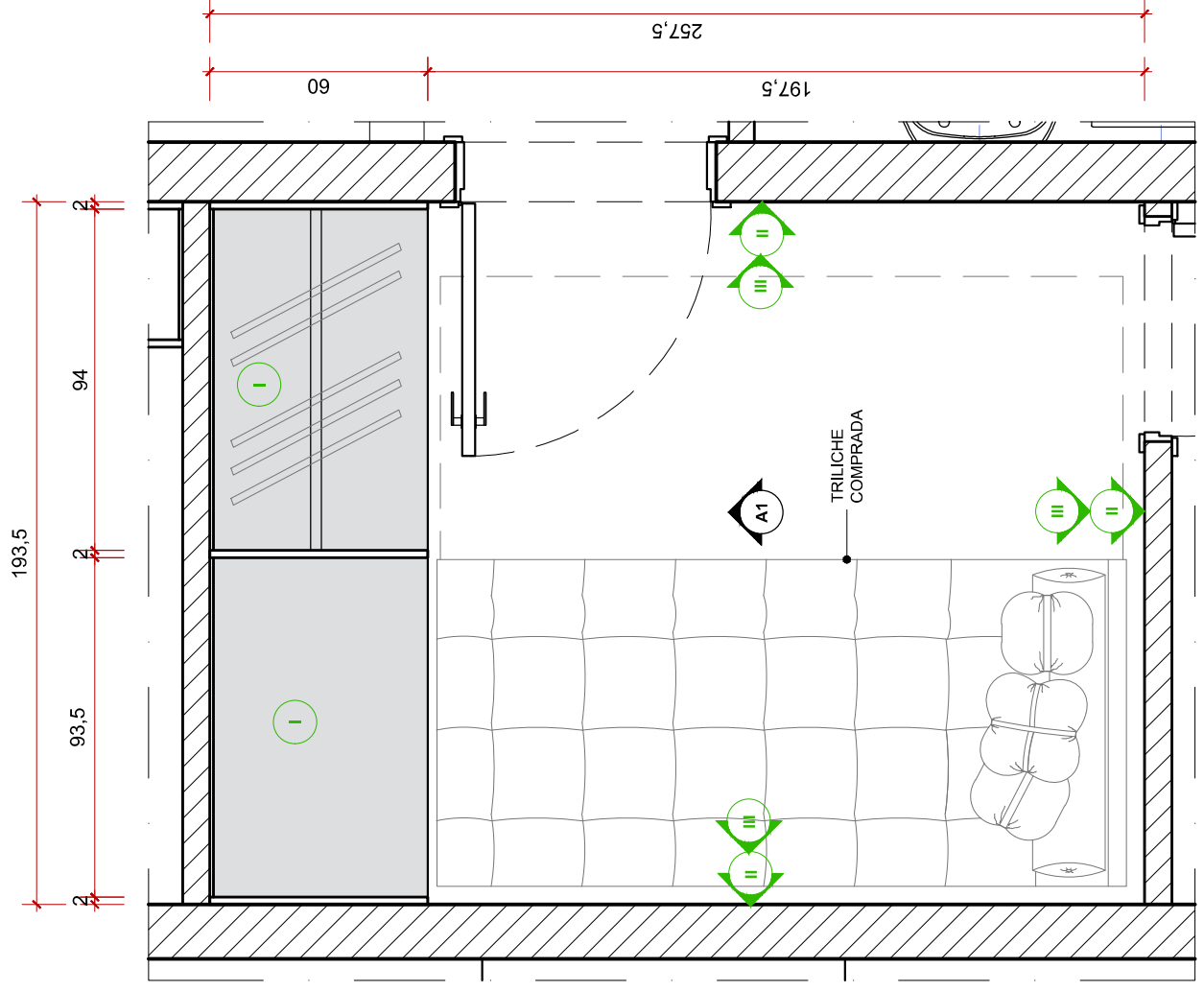

PLANTA EXECUTIVA - DORMITÓRIO FEM.

PLANTA BAIXA
ESC.: 1:20

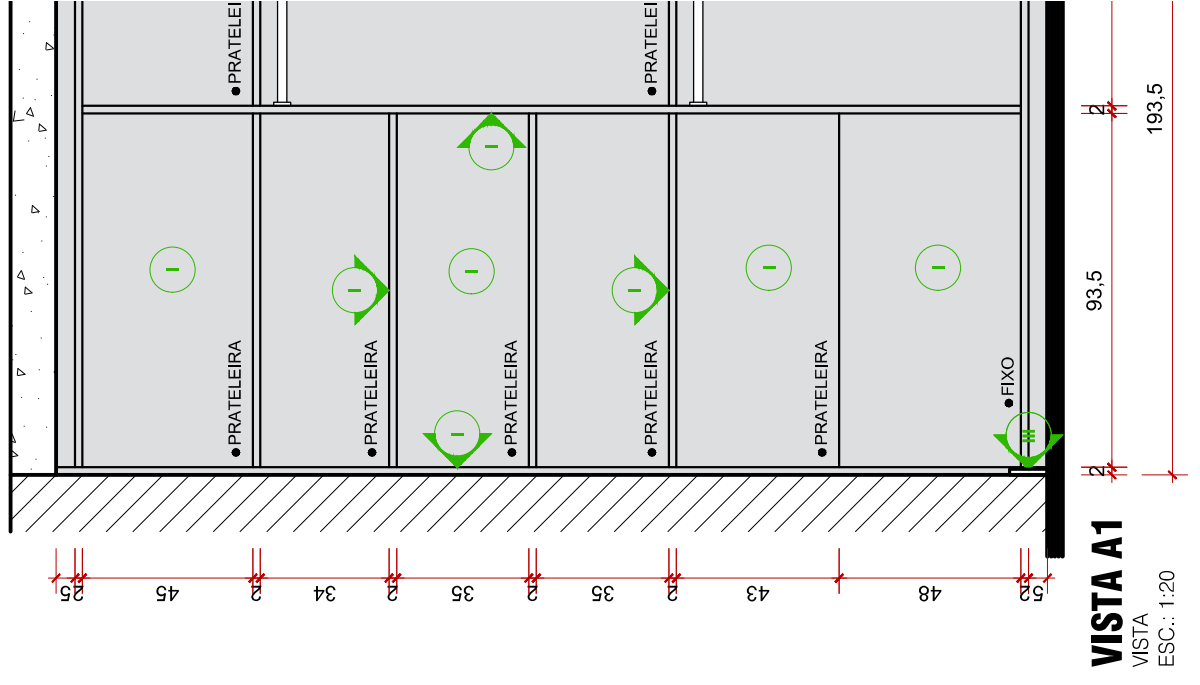

VISTA A1

VISTA
ESC.: 1:20

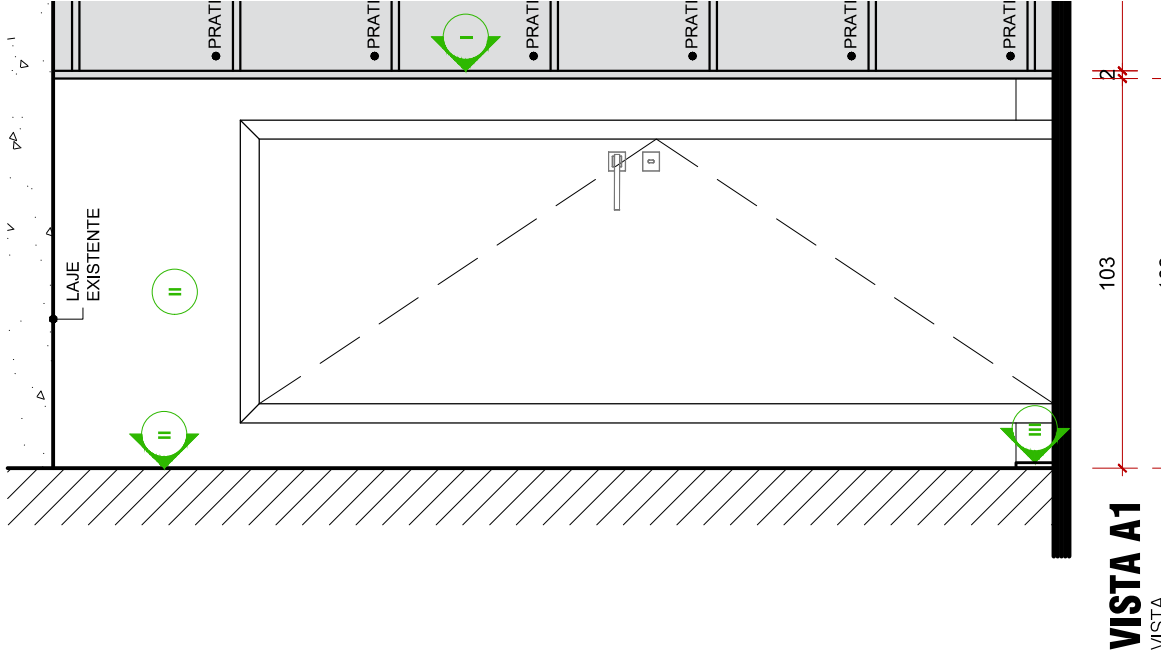
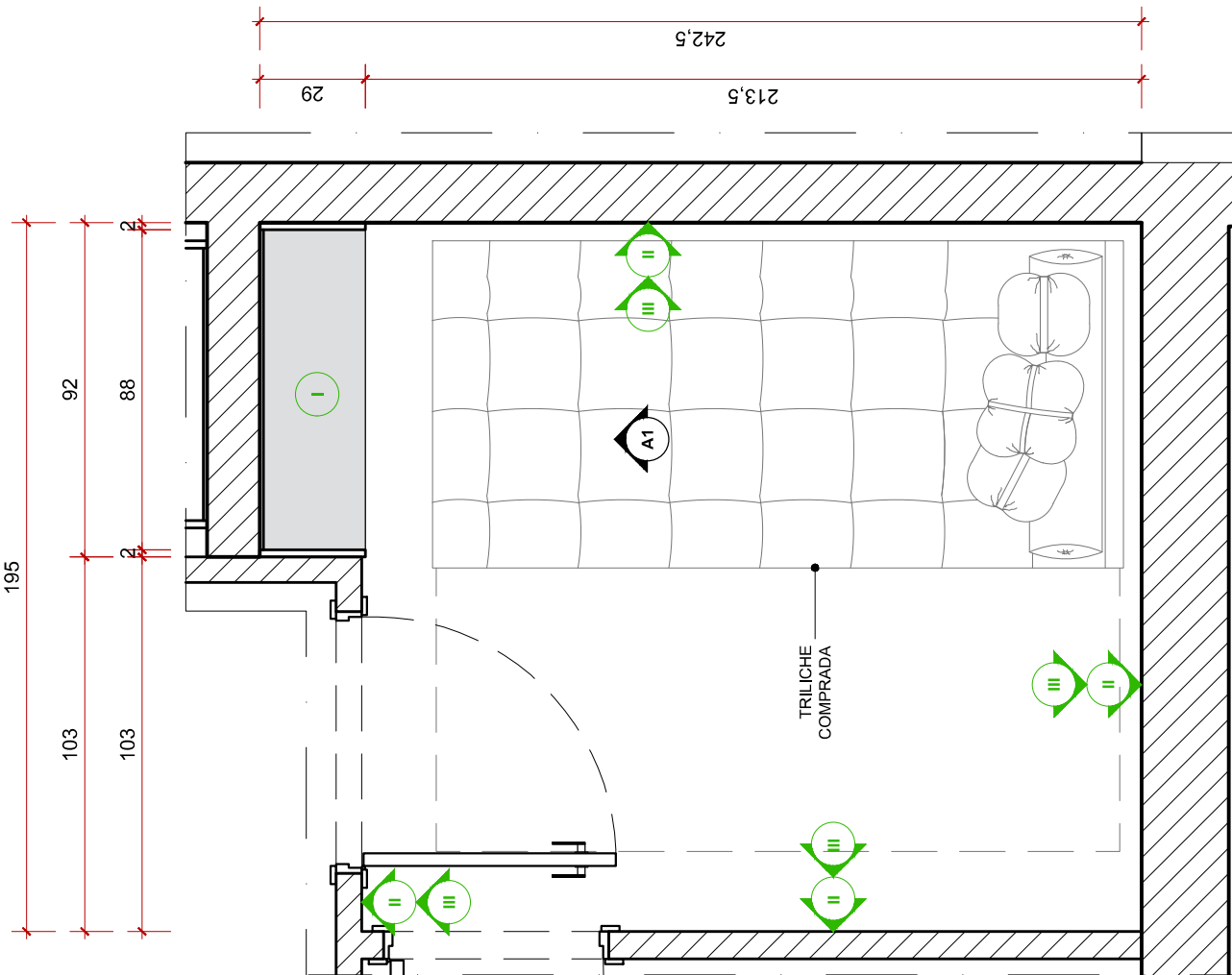

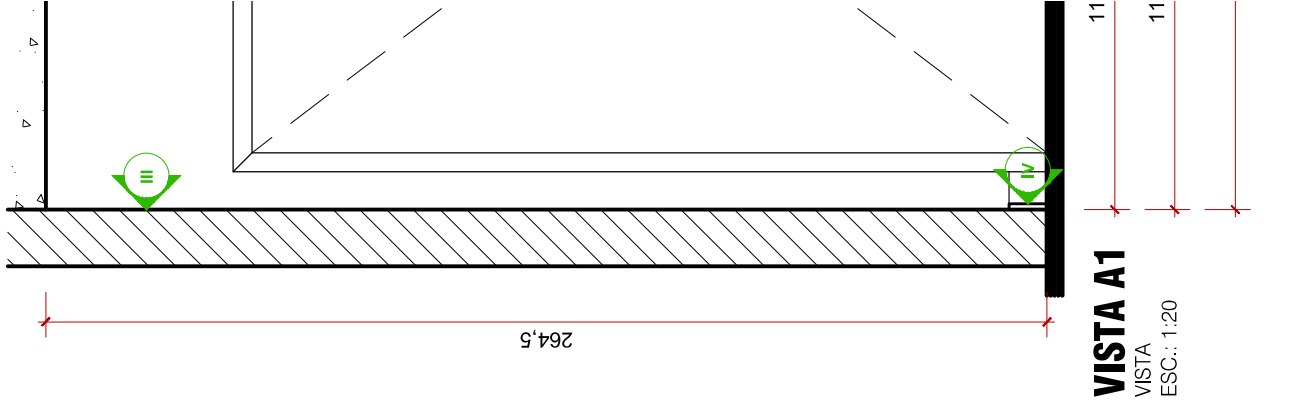
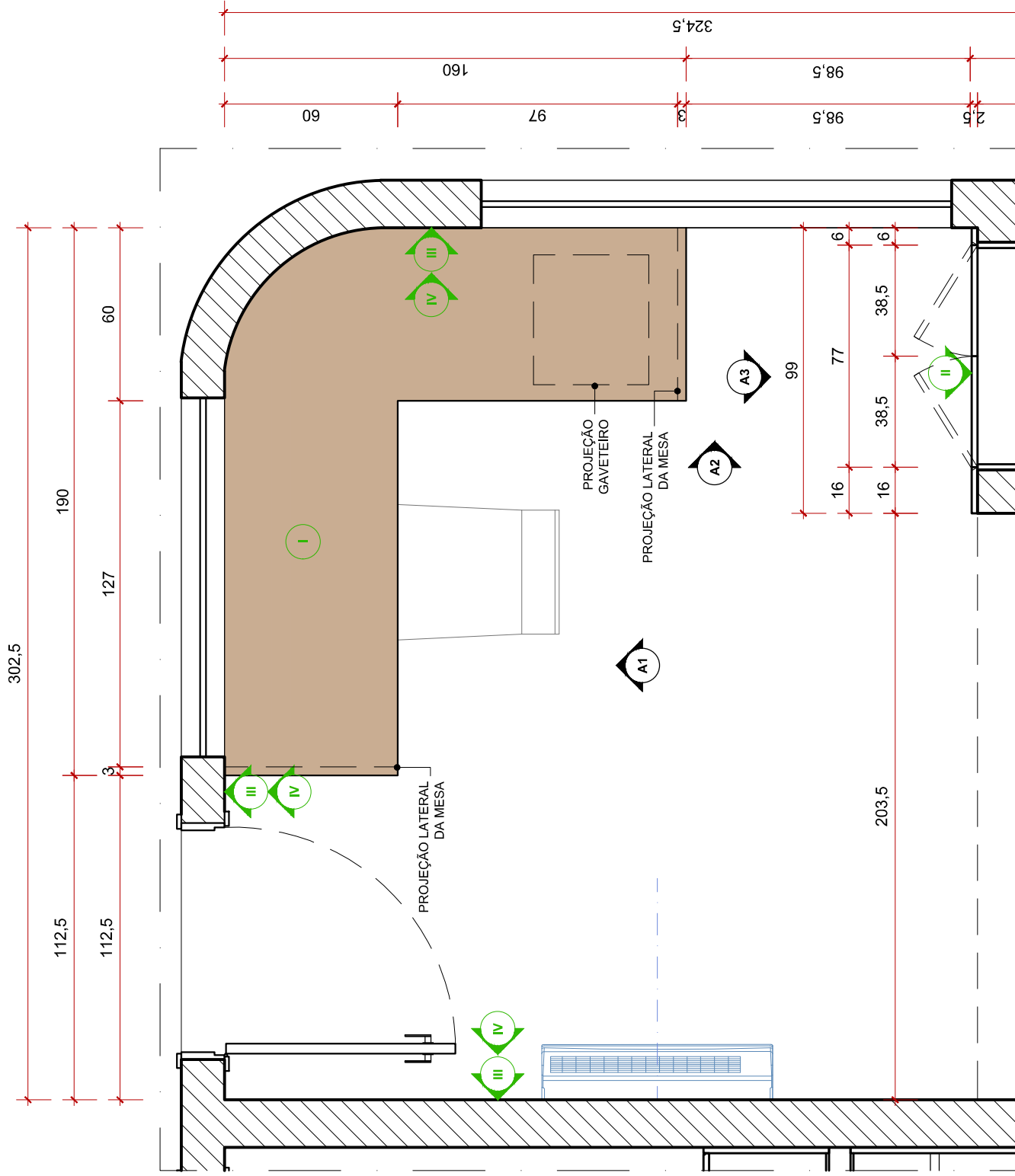

VISTA A1

VISTA
ESC.: 1:20

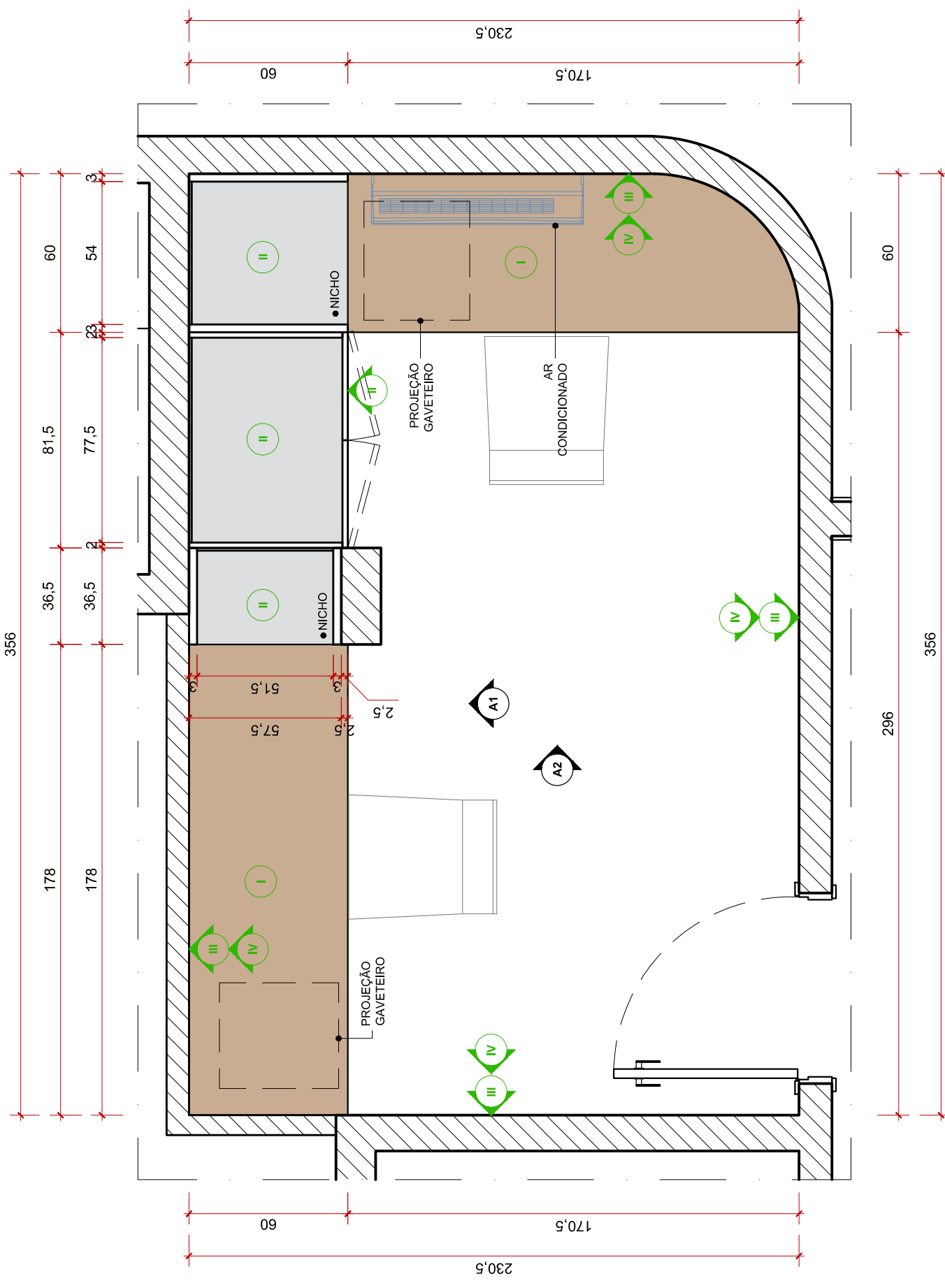

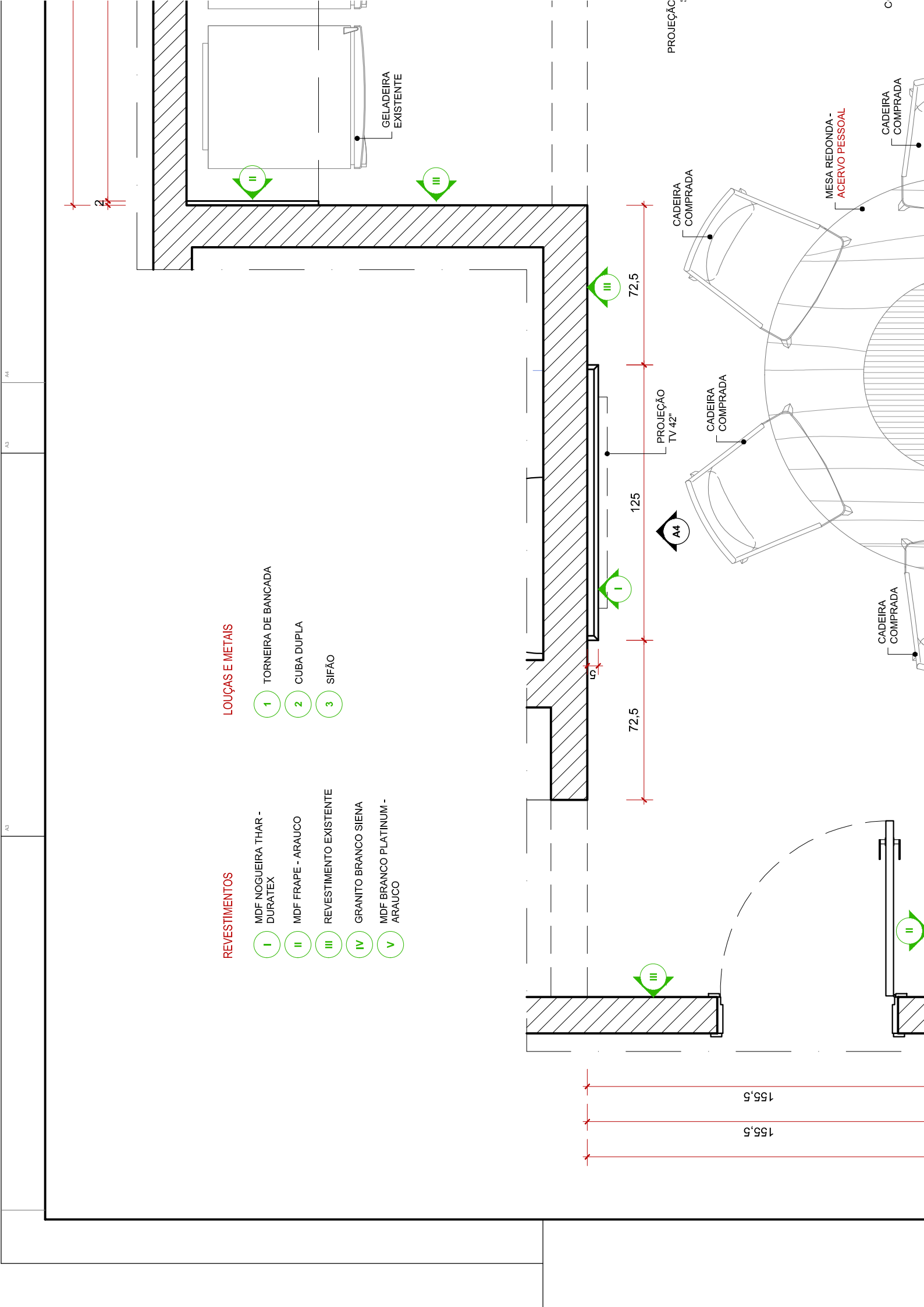

REVESTIMENTOS

- I** MDF NOGUEIRA THAR - DURATEX
- II** MDF FRAPE - ARAUCO
- III** REVESTIMENTO EXISTENTE
- IV** GRANITO BRANCO SIENA
- V** MDF BRANCO PLATINUM - ARAUCO

LOUÇAS E METAIS

- 1** TORNEIRA DE BANCADA
- 2** CUBA DUPLA
- 3** SIFÃO

155,5
155,5

72,5
125
72,5

A4

PROJEÇÃO TV 42"

CADEIRA COMPRADA

CADEIRA COMPRADA

MESA REDONDA - ACERVO PESSOAL

CADEIRA COMPRADA

CADEIRA COMPRADA

GELADEIRA EXISTENTE

PROJEÇÃO

C

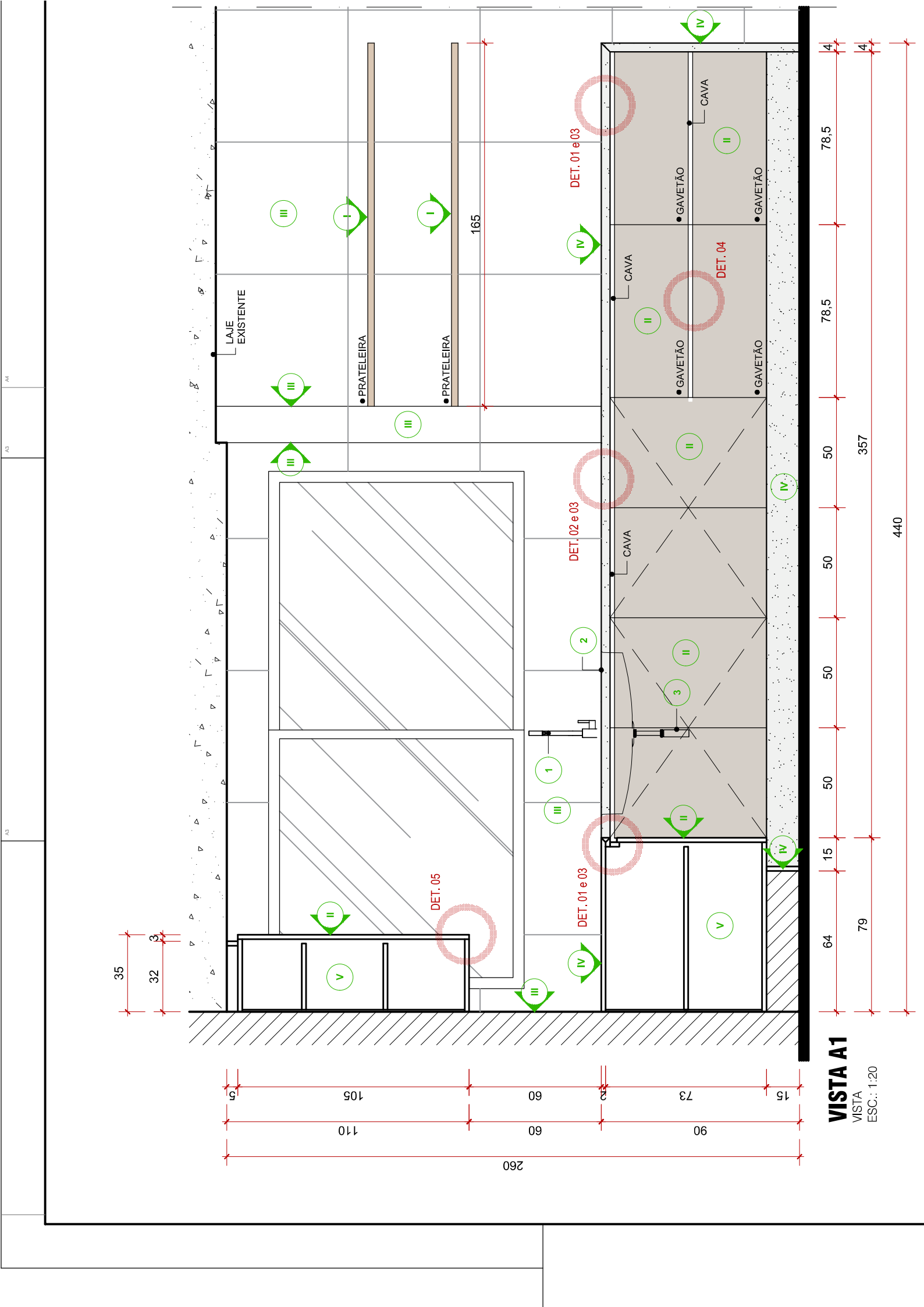

35

32

3

5

105

60

2

73

15

110

60

90

260

LAIJE EXISTENTE

● PRATELEIRA

● PRATELEIRA

165

DET. 05

DET. 02 e 03

DET. 01 e 03

DET. 04

CAVA

CAVA

CAVA

● GAVETÃO

● GAVETÃO

● GAVETÃO

● GAVETÃO

4

78,5

50

50

50

50

15

64

79

357

79

440

VISTA A1
VISTA
ESC.: 1:20

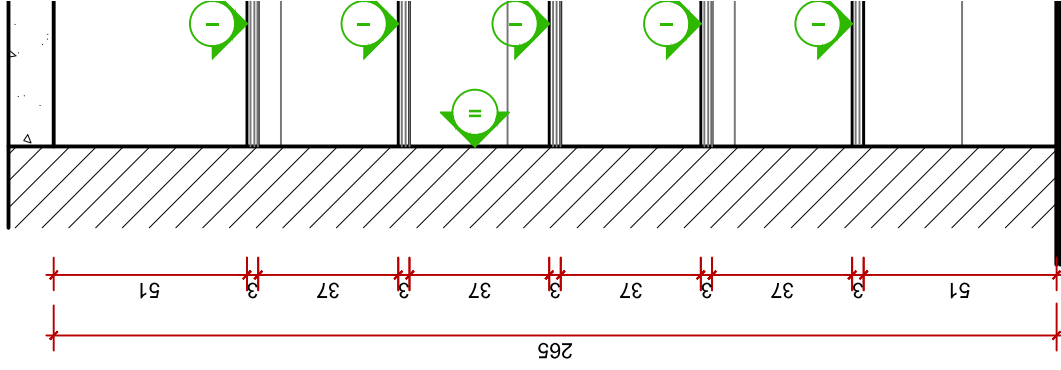

VISTA A2
 VISTA
 ESC.: 1:20

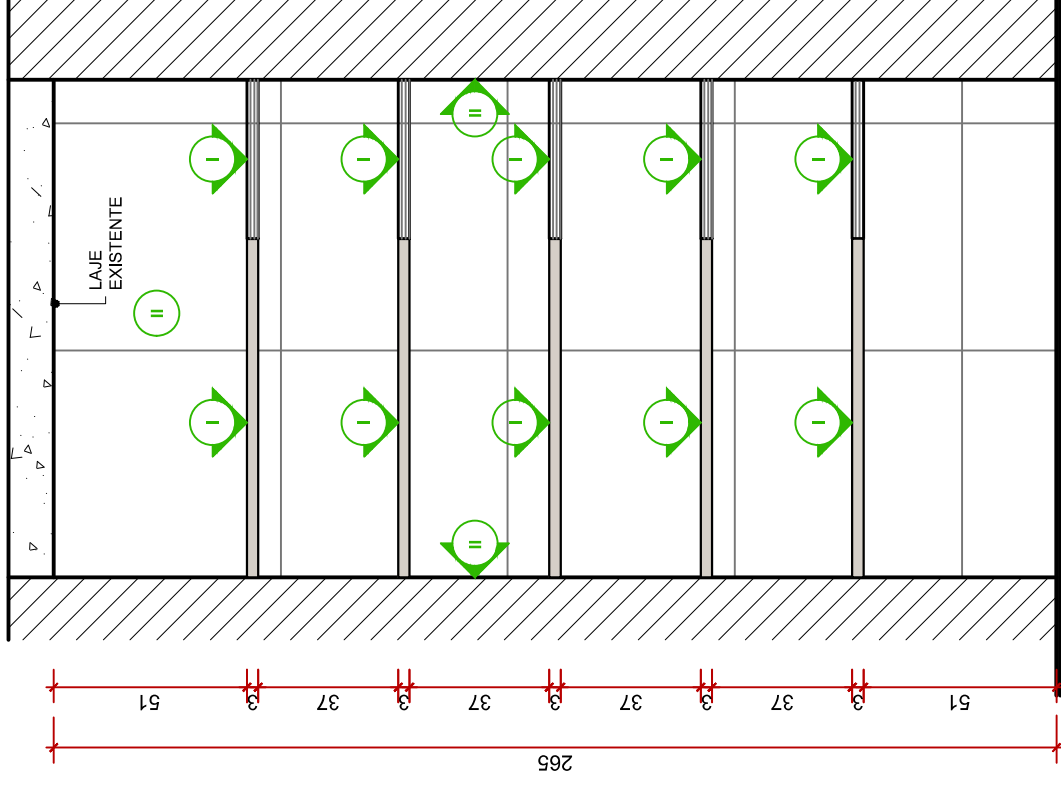

VISTA A1
 VISTA
 ESC.: 1:20

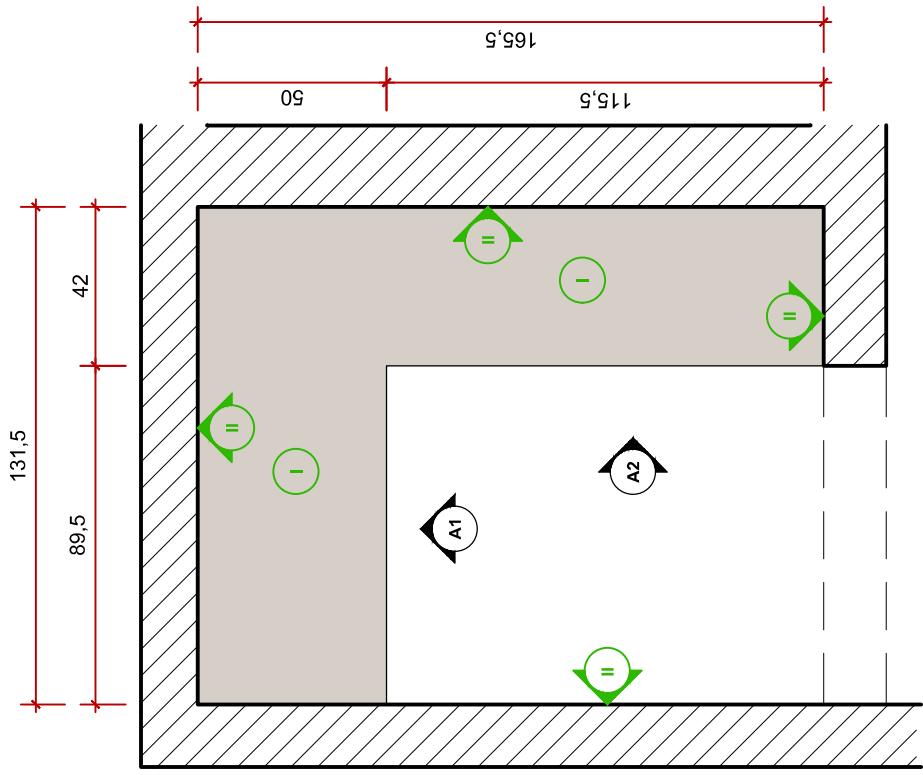

PLANTA EXECUTIVA - DESPENSA
 PLANTA BAIXA
 ESC.: 1:20

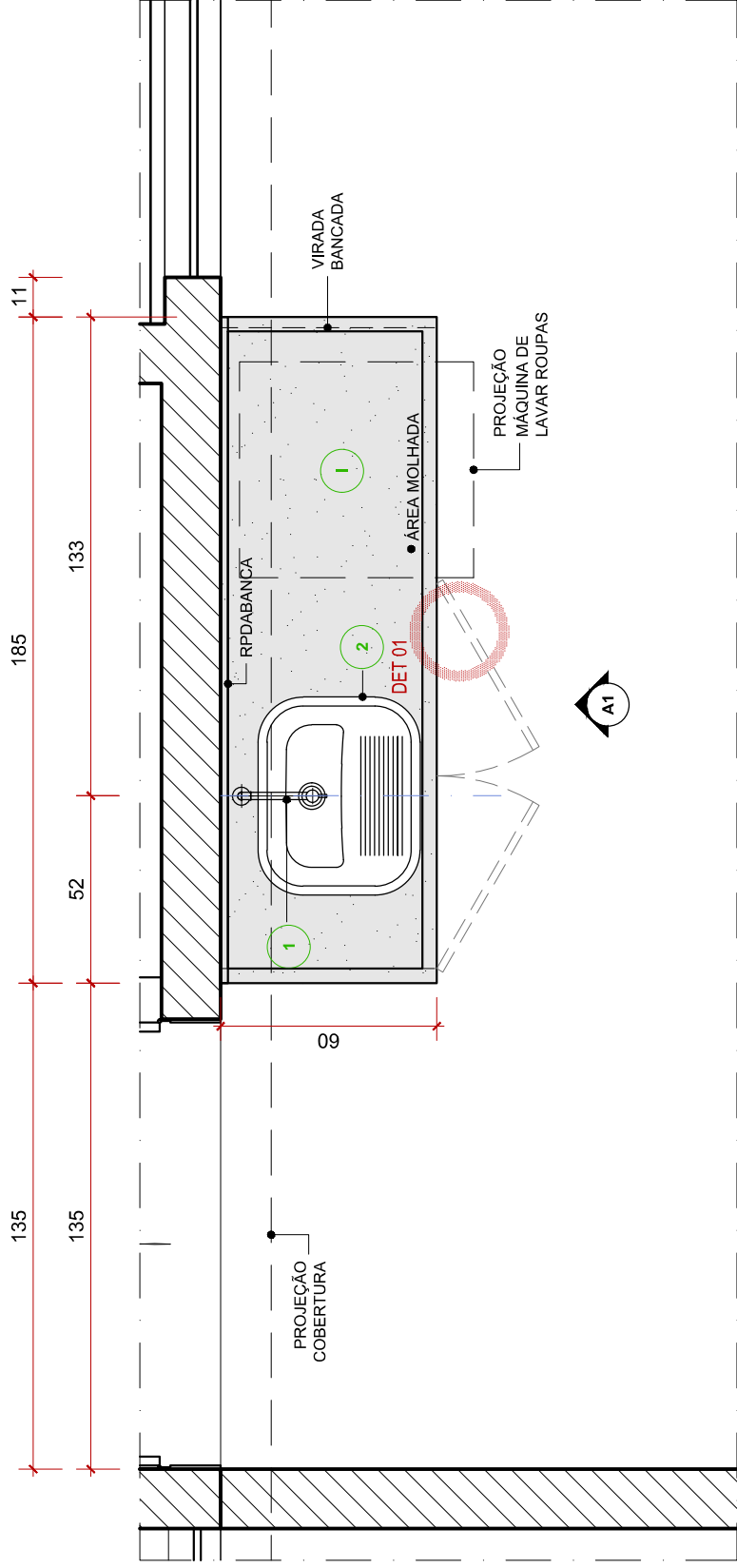

PLANTA EXECUTIVA - ÁREA DE SERVIÇO

PLANTA BAIXA
ESC.: 1:20

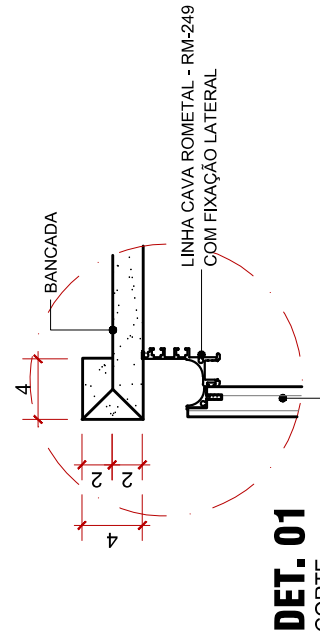

VISTA A1

VISTA
ESC.: 1:20

LOUÇAS E METAIS

- 1 CUBA DE EMBUTIR - EXISTENTE
- 2 TORNEIRA - EXISTENTE
- 3 CABIDE QUADRATTA CROMADO, DECA - CÓD.: 2060.C83
- 4 REGISTRO DE GAVETA - EXISTENTE
- 5 ARANDELA FIT SLIM DE LED LUZ DIRETA - LUNA LUCE

REVESTIMENTOS

- I BANCADA - EXISTENTE
- II ESPELHO
- III MDF FRAPÉ - ARAUCO
- IV MDF NOGUEIRA THAR - DURATEX
- V MDF BRANCO PLATINUM - ARAUCO
- VI REVESTIMENTO - EXISTENTE

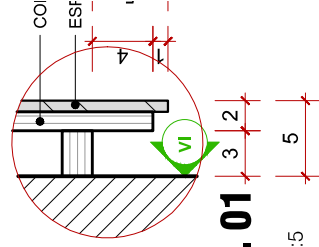

DET. 01

CORTE

ESC.: 1:5

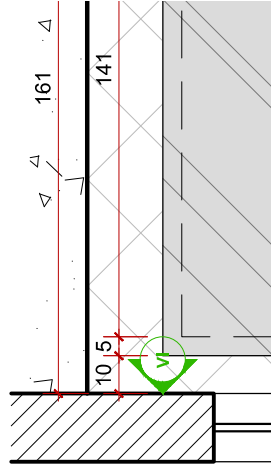
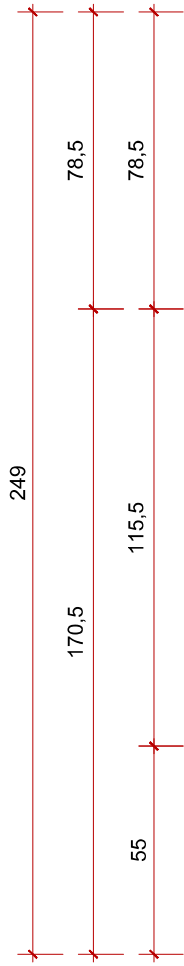

LOUÇAS E METAIS

- I** CUBA DE EMBUTIR - EXISTENTE
- II** TORNEIRA - EXISTENTE
- III** CABIDE QUADRATA CROMADO, DECA - COD.: 2060.C83
- IV** REGISTRO DE GAVETA - EXISTENTE
- V** PERFIL DE EMBUTIR SLIM LINEAR

REVESTIMENTOS

- I** BANCADA - EXISTENTE
- II** ESPELHO
- III** LACA BRANCA
- IV** MDF BRANCO PLATINUM - ARAUCO (INTERNO DE ARMÁRIO)
- V** REVESTIMENTO - EXISTENTE
OBS.: RECOMENDA-SE UTILIZAR PINTURA EPOXI NOS REVESTIMENTOS DAS PAREDES)

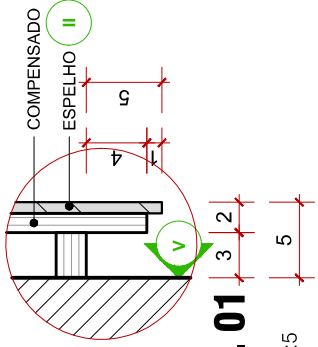

DET. 01

CORTE
ESC.: 1:5

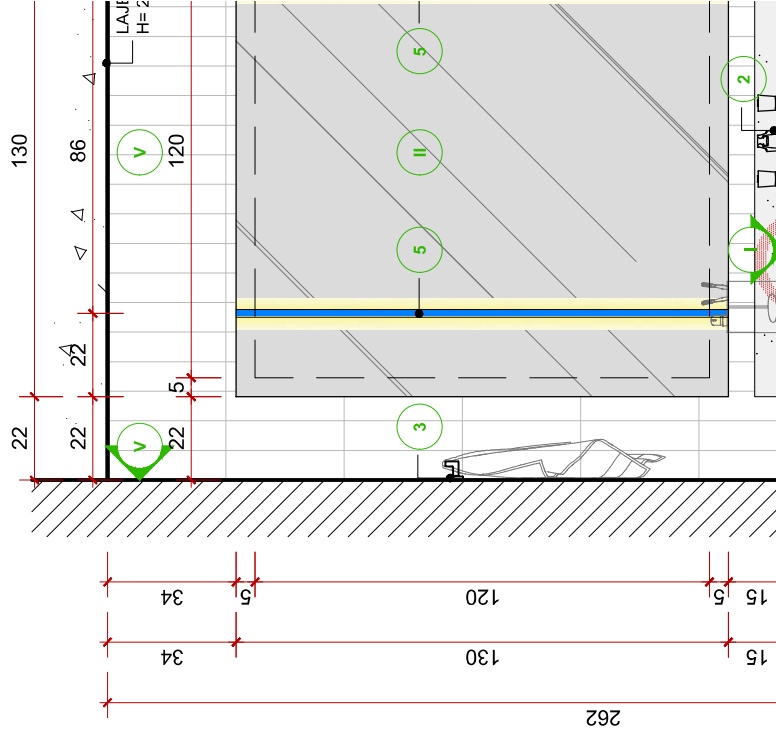
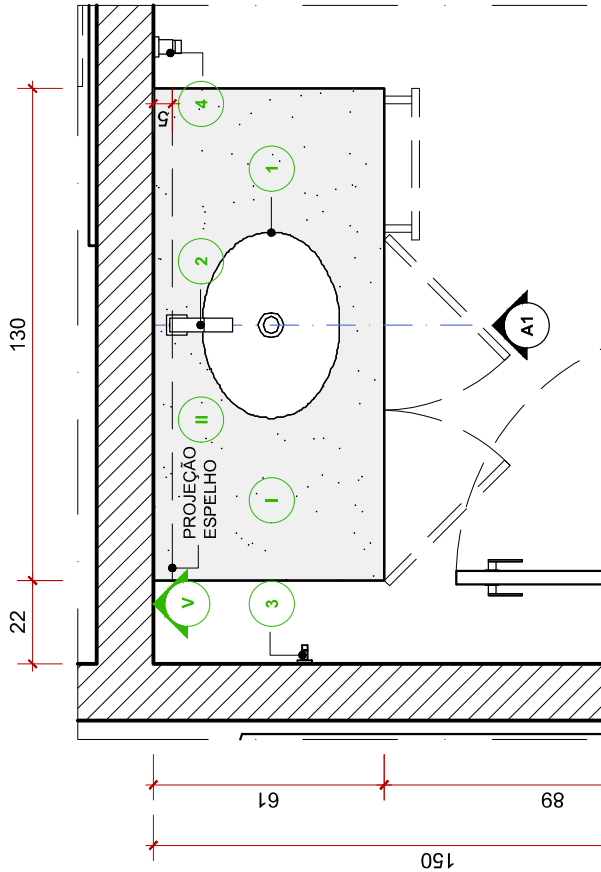

LOUÇAS E METAIS

- I** CUBA DE APOIO - EXISTENTE
- II** TORNEIRA - EXISTENTE
- III** CABIDE QUADRATA CROMADO,
DECA - CÔD.: 2060.C83
- IV** REGISTRO DE GAVETA - EXISTENTE

REVESTIMENTOS

- I** BANCADA - EXISTENTE
- II** ESPELHO - EXISTENTE
- III** MDF FRAPÉ - ARAUCO
- IV** MDF BRANCO PLATINUM - ARAUCO
(INTERNO DE ARMÁRIO)
- V** REVESTIMENTO - EXISTENTE

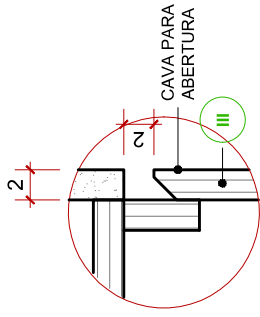

DET. 01 - CAVA

CORTE
ESC.: 1:5

159

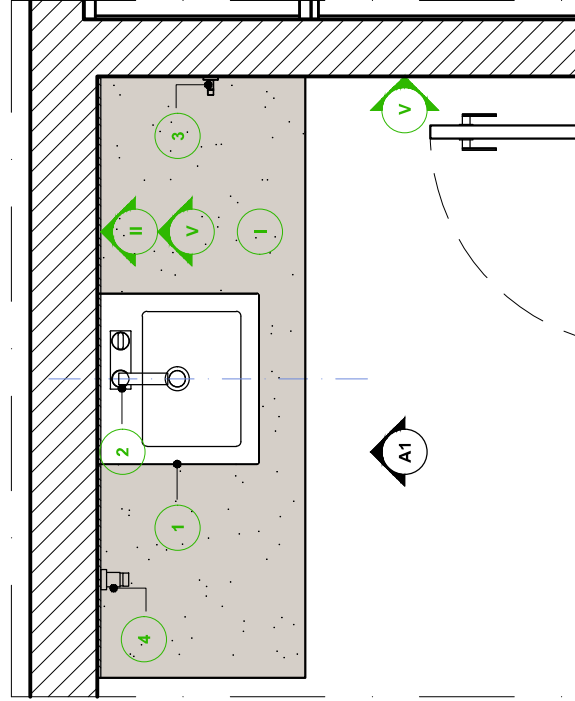

55

148

93

260

185

185

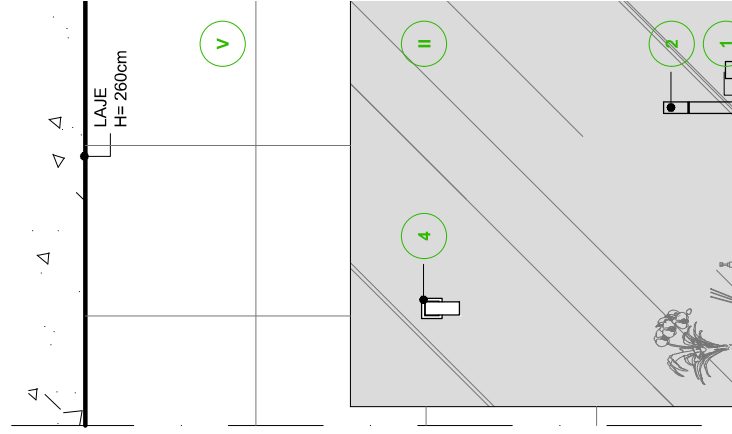

LAJE
H= 260cm